



TensiTrak® Pullback and Pressure Monitoring System

Operator's Manual



DCI Headquarters
19625 62nd Ave. S., Suite B-103
Kent, Washington 98032 USA
Tel 425 251 0559 / 800 288 3610 Fax 253 395 2800
E-mail DCI@digital-control.com www.digitrak.com

DCI Europe

Kurmainzer Strasse 56
D-97836 Bischbrunn
Germany
Tel +49(0) 9394 990 990
Fax +49(0) 9394 990 999
DCI.Europe@digital-control.com

DCI India

DTJ 1023, DLF Tower A
Jasola District Center
New Delhi 110 044, India
Tel +91(0) 11 4507 0444
Fax +91(0) 11 4507 0440
DCI.India@digital-control.com

DCI China

No. 368, Xingle Road
Huacao Town, Minhang District
Shanghai P.R.C. 201107
Tel +86(0) 21 6432 5186
Fax +86(0) 21 6432 5187
DCI.China@digital-control.com

DCI Australia

2/9 Frinton Street
Southport, Queensland 4215
Australia
Tel +61(0) 7 5531 4283
Fax +61(0) 7 5531 2617
DCI.Australia@digital-control.com

DCI Russia

420059 Pavlyukhina Street
104, Kazan
Russia
Tel +7 843 277 52 22
Fax +7 843 277 52 07
DCI.Russia@digital-control.com

3-1500-00-A1

© 2011 by Digital Control Incorporated. All rights reserved. October 2011 edition.

Trademarks

The DCI logo, CableLink[®], DataLog[®], DigiTrak[®], Eclipse[®], F2[®], iGPS[®], MFD[®], SST[®], *target-in-the-box*[®], *Target Steering*[®], and TensiTrak[®] are U.S. registered trademarks and DucTrak[™], F5[™], F Series[™], FSD[™], *FasTrak*[™], LWD[™], SE[™], SED[™], SuperCell[™], and TeleLock[™] are trademarks of Digital Control Incorporated.

Limited Warranty

All products manufactured and sold by Digital Control Incorporated (DCI) are subject to the terms of a Limited Warranty. A copy of the Limited Warranty is included at the end of this manual; it can also be obtained by contacting DCI Customer Service, 425-251-0559 or 800-288-3610, or by connecting to DCI's website, www.digitrak.com.

Important Notice

All statements, technical information, and recommendations related to the products of DCI are based on information believed to be reliable, but the accuracy or completeness thereof is not warranted. Before utilizing any DCI product, the user should determine the suitability of the product for its intended use. All statements herein refer to DCI products as delivered by DCI and do not apply to any user customizations not authorized by DCI nor to any third-party products. Nothing herein shall constitute any warranty by DCI nor will anything herein be deemed to modify the terms of DCI's existing Limited Warranty applicable to all DCI products.

FCC Compliance Statement

This equipment complies with Part 15 of the Rules of the FCC. Operation is subject to the following two conditions: (1) this device may not cause harmful interference, and (2) this device must accept any interference received, including interference that may cause undesired operation. DCI is responsible for FCC compliance in the United States: Digital Control Incorporated, 19625 62nd Ave. S., Suite B-103, Kent, WA 98032; phone 425-251-0559 or 800-288-3610.

Changes or modifications to the DCI equipment not expressly approved and carried out by DCI will void the user's Limited Warranty and the FCC's authorization to operate the equipment.

CE Requirements



DigiTrak receivers are classified as Class 2 radio equipment per the R&TTE Directive and may not be legal to operate or require a user license to operate in some countries. The list of restrictions and the required declarations of conformity are available on DCI's website, www.digitrak.com, under the Service & Support tab. Click on DOWNLOADS and select from the CE Documents pull-down menu to download, view, or print the documents.

Table of Contents

SAFETY PRECAUTIONS AND WARNINGS.....	5
DEAR CUSTOMER:.....	7
INTRODUCTION.....	9
SYSTEM COMPONENTS.....	11
F5 TensiTrak Transmitter	11
F5 Receiver	12
FSD or MFD Remote Display	13
LWD Software.....	13
Bluetooth USB Adapter	14
SETTING UP TENSITRAK SYSTEM	15
Powering On TensiTrak Transmitter.....	15
Setting up Receiver and Remote.....	15
Calibrating TensiTrak Transmitter to Receiver and Verifying Calibration	17
Setting Up TensiTrak Downhole Assembly	18
RECORDING DATA AND USING RECEIVER MENUS.....	19
Pressure-Tension DataLog Menu.....	19
Start Recording Menu.....	20
Stop/Pause Recording Menu.....	21
Flag Recording Menu	21
Deleting TensiTrak Jobs.....	22
INSTALLING LWD SOFTWARE.....	23
Computer System Requirements	23
Installation Instructions	23
UPLOADING DATA FROM RECEIVER TO COMPUTER	25
Adding F5 Receiver to LWD Bluetooth Device List.....	25
On the Receiver	25
On the Computer.....	26
Uploading Data from Receiver to Computer	27
On the Receiver	27
On the Computer.....	27
USING LWD SOFTWARE	29
Starting LWD Program and Opening Files	29
Menu and Tool Bars	31
File Menu Commands	31
Edit Menu Commands.....	32
View Menu Commands	32
Window Menu Commands.....	33
Help Menu Commands	33

Table of Contents (Continued)

USING LWD SOFTWARE (Continued)	
Information Fields	33
Site Information	33
Job Information	34
Data Point List	34
Pressure and Force Charts	35
Editing and Annotating Charts	36
Removing Data Points	36
Drawing Shapes and Adding Captions	36
Editing Chart Properties	37
Printing and Previewing Project Reports	38
Saving Project Files	38
E-mailing Report to Customer Who Does Not Have LWD Software	39
APPENDIX: SYSTEM SPECIFICATIONS AND MAINTENANCE REQUIREMENTS..... 41	
Power Requirements	41
Environmental Requirements	41
Tension Monitor Pull-Force Data Accuracy	41
Mud Pressure Data Accuracy	41
General Transmitter Care Instructions	42
Battery Pack Storage	42
LIMITED WARRANTY	

Safety Precautions and Warnings

IMPORTANT NOTE: All operators must read and understand the following safety precautions and warnings and must review this manual as well as the operator's manual that came with your DigiTrak F5 Locating System before using the DigiTrak F5 TensiTrak Pullback and Pressure Monitoring System.

 Serious injury and death can result if underground drilling equipment makes contact with an underground utility such as a high-voltage electrical cable or a natural gas line.

 Substantial property damage and liability can result if underground drilling equipment makes contact with an underground utility such as a telephone, cable TV, fiber-optic, water, or sewer line.

 Work slowdowns and cost overruns can occur if drilling operators do not use the drilling or locating equipment correctly to obtain proper performance.

- Directional drilling operators **MUST** at all times:
 - Understand the safe and proper operation of drilling and locating equipment, including the use of ground mats and proper grounding procedures.
 - Ensure that all underground utilities have been located, exposed, and marked accurately prior to drilling.
 - Wear protective safety clothing such as dielectric boots, gloves, hard-hats, high-visibility vests, and safety glasses.
 - Locate and track the transmitter in the drill head accurately and correctly during drilling.
 - Maintain a minimum distance of 8 in. (20 cm) from the front of the receiver to the user's torso to ensure compliance with FCC requirements.
 - Comply with federal, state, and local governmental regulations (e.g., OSHA).
 - Follow all other safety procedures.
- The TensiTrak system is intended for use during the pullback of product only. Pushing on the TensiTrak transmitter could cause damage to the transmitter.
- Before each installation, inspect the TensiTrak transmitter's battery cap and mud pressure sensor for damage or wear.
- The TensiTrak system should be tested prior to use to verify accuracy of readings.
- Remove the batteries from all system components during shipping and prolonged storage; damage caused by leakage may occur.

 DCI equipment is not explosion-proof and should never be used near flammable or explosive substances.

Safety Precautions and Warnings (Continued)



BATTERY DISPOSAL: This symbol on equipment indicates that the equipment must not be disposed of with your other household waste. Instead, it is your responsibility to dispose of such equipment by handing it over to a designated collection point for the recycling of batteries or electrical and electronic equipment. If the equipment contains a banned substance, the label will show the pollutant (Cd = Cadmium; Hg = Mercury; Pb = Lead) near this symbol. The separate collection and recycling of your waste equipment at the time of disposal will help to conserve natural resources and ensure that it is recycled in a manner that protects human health and the environment. For more information about where you can drop off your waste equipment for recycling, please contact your local city office, your household waste disposal service, or the shop where you purchased the equipment.

- Interference can cause significant inaccuracies in the measurement of depth and the TensiTrak transmitter's range capability. You should always perform a background noise check prior to starting a pullback operation.
 - Sources of interference include but are not limited to traffic signal loops, invisible dog fences, cable TV, power lines, fiber-trace lines, metal structures, cathodic protection, telephone lines, cell phones, transmission towers, conductive earth, salt, salt water, rebar, radio frequencies, and other unknown sources of interference.
 - Interference with the operation of the remote display may also occur from other sources operating nearby on the same frequency, such as car rental agencies using their remote check-in modules, other directional drilling locating equipment, etc.
- During pullback, if depths are being tracked they will not be accurate unless:
 - The receiver has been properly calibrated and the calibration has been checked for accuracy so that the receiver shows the correct depth.
 - The TensiTrak transmitter has been located correctly and accurately and the receiver is directly above it.
 - The receiver is held at the height-above-ground distance, which has been set correctly, or placed on the ground for depth measurements.
- The TensiTrak transmitter is positioned behind the reamer between the swivel and the product so that the transmitter does not rotate.
- Exposure to extreme vibration could damage the TensiTrak transmitter and/or the batteries and possibly reset the recorded maximum pull force.
- Exposure to downhole fluid pressures above 127 psi (876 kPa) could damage the TensiTrak transmitter.
- The TensiTrak transmitter should never be shrouded with a metal pipe. If a shroud is required, it must be a nonmetallic shroud.
- Avoid pressure washing directly into the mud pressure sensor.
- Do not weld on the TensiTrak transmitter.
- Carefully review this operator's manual and be sure you always operate the TensiTrak system properly to obtain accurate pullback, pressure, and depth data. If you have any questions about the operation of the TensiTrak system, please call DCI Customer Service at any of the phone numbers provided on the cover, and we will do our best to assist you.

Dear Customer:

Thank you for choosing the DigiTrak F5 TensiTrak Pullback and Pressure Monitoring System. We are proud of the equipment that we have been designing and building in Washington State since 1990. We believe in providing a unique, high-quality product *and* standing behind it with superior customer service and training.

Please take the time to read this entire manual—especially the section on safety. Also, please fill in the product registration card provided with this equipment, and mail it to DCI headquarters or fax it to us at 253-395-2800; you can also complete and submit the form online at our website. We will put you on the Digital Control mailing list and send you product upgrade information and our *FasTrak* newsletter.

Feel free to contact us at any of our global offices listed on the front cover if you have any problems or questions. Our Customer Service Department is available 24 hours a day, 7 days a week to provide assistance.

As the horizontal directional drilling industry grows, we're keeping our eye on the future to develop equipment that will make your job faster and easier. Stay current by visiting our website on the internet at www.digitrak.com or by giving us a call.

We welcome questions, comments, and ideas.

Digital Control Incorporated
Kent, Washington
2011

Notes

Introduction



F5 TensiTrak System

The DigiTrak F5 TensiTrak Pullback and Pressure Monitoring System allows you to monitor and save live pullback data electronically during horizontal directional drilling installations. The TensiTrak transmitter is a self-contained wireless device that measures and transmits real-time pullback data that includes product pull forces and downhole mud pressures. It is placed behind the reamer between a swivel and the product. The data is monitored and saved using an F5 receiver, which also transmits the data in real time to the remote display at the drill rig. The data saved in the receiver is uploaded to a computer using the LWD (log-while-drilling) software provided with the F5 system.

The following types of data are monitored and saved with the F5 TensiTrak system:

Monitored and saved on receiver

- Real-time pull force
- Maximum pull force
- Real-time downhole mud pressure

Monitored only on receiver

- TensiTrak temperature
- TensiTrak battery status
- TensiTrak depth and position

Saved on TensiTrak transmitter

- Maximum pull force

This operator's manual begins by describing the primary components of the TensiTrak system, which include the TensiTrak transmitter, the F5 receiver, the FSD or MFD remote display, the LWD computer software, and the Bluetooth adapter used for communication between the receiver and the computer. Then it presents procedures for setting up the TensiTrak system in the field, recording data in the field, installing the LWD software, and using the software to upload, edit, view, archive, and e-mail TensiTrak data.

Some terms and techniques used in this manual are considered basic to the F5 locating system. If you have never used the F5 system, then you are required to read the operator's manual for the system (*DigiTrak F5 Directional Drilling Locating System Operator's Manual*) before using the TensiTrak system.

NOTE: You must know how to operate the F5 locating system prior to operating the F5 TensiTrak system.

You also must read the instructions in this TensiTrak system operator's manual and familiarize yourself with the various menu screens on your F5 receiver before using the system for a pullback. If you have questions, please call DCI Customer Service.

System Components

The F5 TensiTrak system has five main components, which are described in this section.

- F5 TensiTrak Transmitter – A battery-powered device with sensors that continuously measure pullback data along with depth, position, temperature, and battery life and a transmitter that sends the data to an F5 receiver.
- F5 Receiver – A locator or receiver used to display and record transmitter data; the data is then uploaded from the receiver to a computer.
- FSD or MFD Remote Display – A remote display used to view TensiTrak data at the drill rig.
- LWD Software – A computer application provided with the F5 system for uploading data from the receiver to a computer and for working with the TensiTrak data in the computer.
- Bluetooth USB Adapter – A USB device required for the computer to communicate with the F5 receiver to upload data.

F5 TensiTrak Transmitter

The F5 TensiTrak transmitter contains sensors that continuously measure the pull force, the downhole mud pressure, and the maximum pull force, which it also saves internally. It also monitors battery life and temperature and can track its position to a maximum depth of 60 ft (18.3 m). The pullback and transmitter data are sent every 4 seconds to the receiver.

The TensiTrak transmitter is 5.5 in. (13.97 cm) in diameter and 19.5 in. (49.53 cm) long. It is installed behind the reamer or hole opener between the swivel and the product. The inner diameter of the pulling eye is 1.77 in. (4.5 cm). If the diameter of the TensiTrak transmitter is smaller than that of the reamer and product, you may want to shroud the transmitter; be sure that this is done with nonmetallic material.

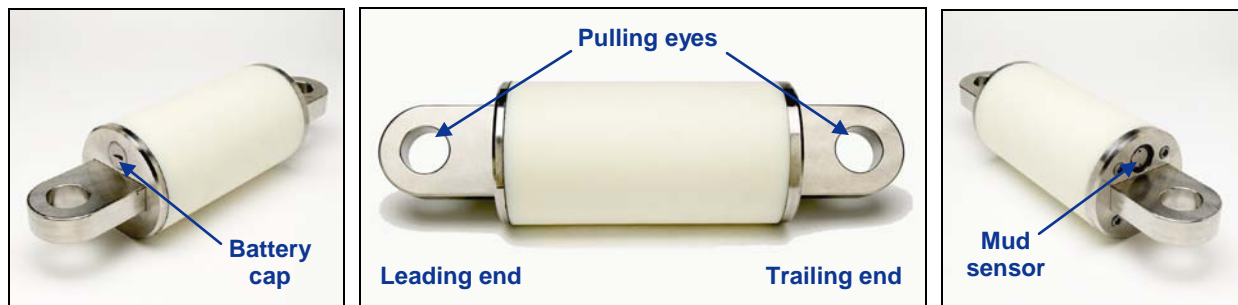

Leading End View

Side View

Trailing End View

F5 TensiTrak Transmitter

F5 Receiver

The F5 receiver monitors the pullback and mud pressure data in real time and sends the data to the remote display on the drill rig. If you want to record the TensiTrak data, then you will use the DataLog function in the receiver. The DataLog function allows you to record your real-time data, to set flags along the pullback path, and to upload your TensiTrak data to a computer. The receiver will save 20 runs of data before uploading to a computer or deleting of jobs is required.

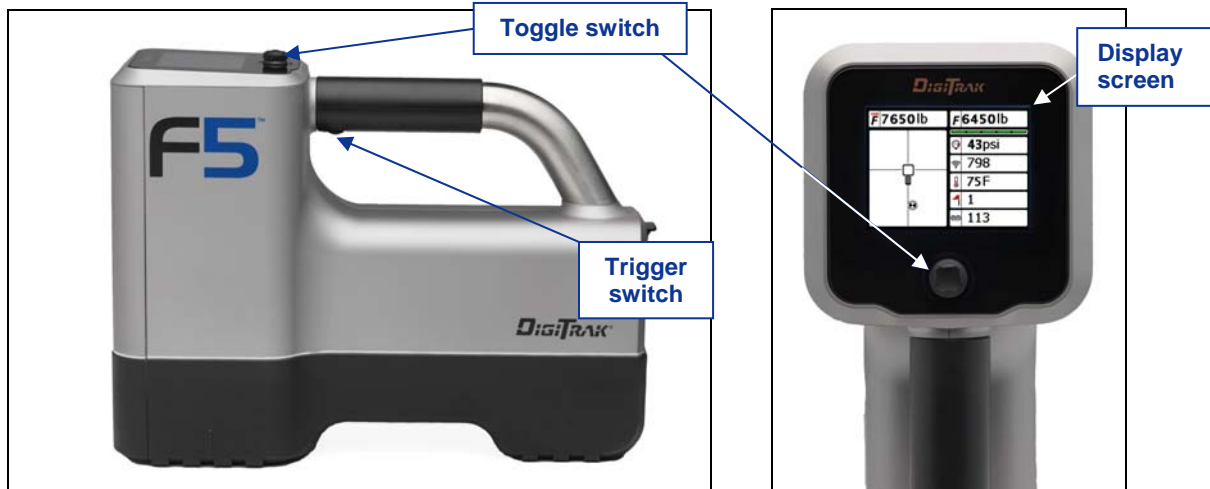

F5 Receiver Side View (left) and Top View (right)

The F5 receiver displays the transmitter's temperature and battery status, and it can also be used to track the position and depth of the TensiTrak transmitter. The receiver must be programmed to detect the TensiTrak transmitter, and the system must be set up correctly for proper communication between the receiver, transmitter, and remote (see next section, *Setting Up TensiTrak System*).

The receiver menus used for TensiTrak pullback jobs are located under the pressure-tension (P-T) DataLog menu, which is located on the receiver main menu. The P-T DataLog menu is also used for the F5 fluid pressure transmitter, but only its applications for the TensiTrak system are addressed in this manual.

FSD or MFD Remote Display

The F Series Display (FSD) or Multi-Function Display (MFD) shows the pull force, mud pressure, and maximum pull force when a TensiTrak transmitter is used with the F5 receiver and the system is properly set up. If you are using the system with an MFD remote display, software updates may be required; please contact DCI Customer Service. For more information about the FSD and MFD remotes, see the *DigiTrak MFD/FSD Operator's Manual*.



DigiTrak FSD Remote (left) and DigiTrak MFD Remote (right)

LWD Software

The LWD software is provided on a USB flash drive that also contains the *DigiTrak LWD (Log-While-Drilling) DataLog System Operator's Manual*, sample drill data, and Bluetooth drivers. The LWD software is used with other LWD applications, such as the Short Steering Tool (SST) system. However, all information that is pertinent to running the TensiTrak system is included in this TensiTrak manual. Instructions for the other LWD applications are not included herein.

The LWD software requires a computer with at least the following system specifications:

- Microsoft Windows XP, Vista, or 7 operating system
- USB port
- Pointing device (mouse)
- Color printer for color graphs

The pressure-tension (P-T) application in the LWD software is used with the TensiTrak system. It allows you to upload TensiTrak data from your F5 (or Eclipse) receiver, and to edit, annotate, and e-mail graphs and job information. A typical TensiTrak job screen as it appears in the LWD application window is shown below.

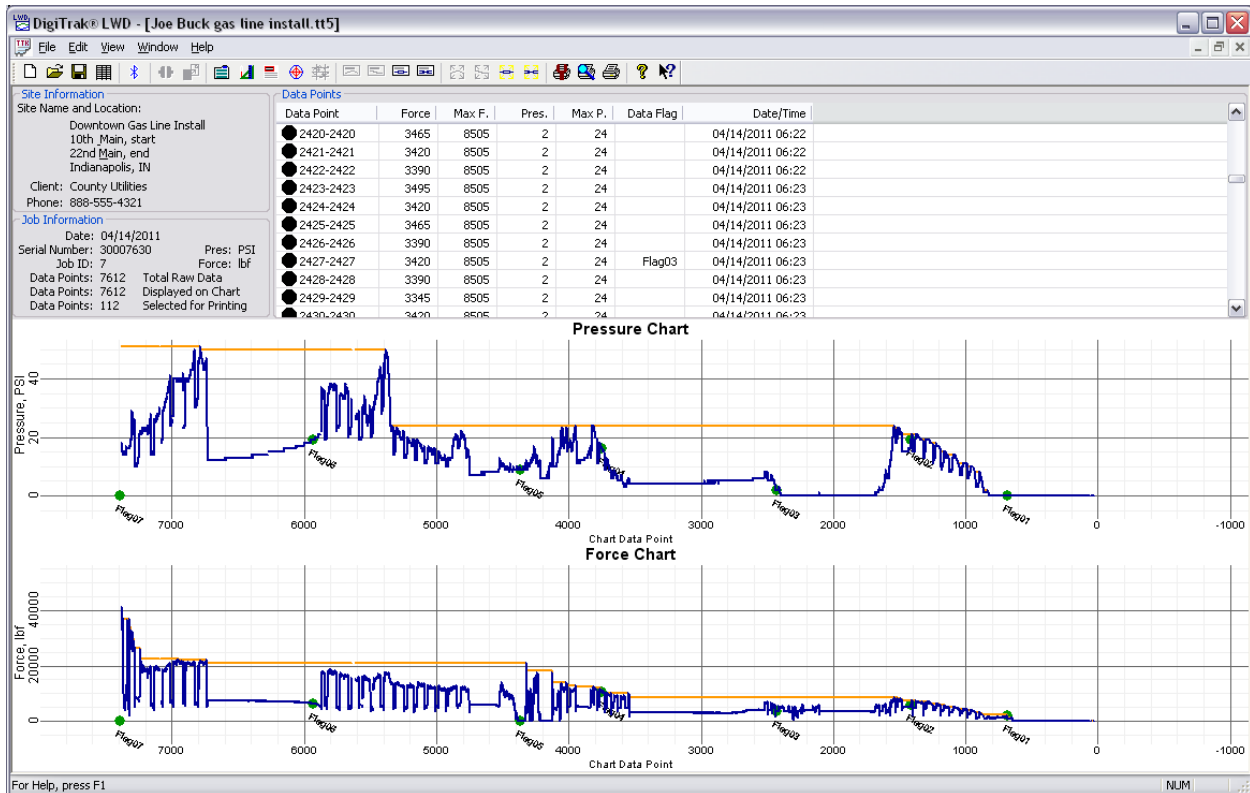

LWD Pressure-Tension Application Window

Bluetooth USB Adapter

The Bluetooth USB adapter (Amp'ed RF Model BT-210) is required for the F5 receiver to communicate with the computer for uploading data. The adapter has its own firmware to communicate and transfer data via Bluetooth technology. Drivers for the Bluetooth adapter are provided on the LWD flash drive and must be loaded before using the adapter to upload data. The LWD software must also be installed on the computer before TensiTrak data can be uploaded.



Bluetooth USB Adapter

Setting Up TensiTrak System

The setup procedure involves powering on the TensiTrak transmitter, the F5 receiver, and the remote display; calibrating the transmitter to the receiver and verifying calibration; and assembling the downhole assembly. The instructions in this section are intended for use by someone who is already familiar with and knows how to use the F5 locating equipment. This section does not explain how to access the various menus or modes or how to check depth or signal strength—it assumes that you know how to do these things. Please refer to the *DigiTrak F5 Directional Drilling Locating System Operator's Manual* if you need to review instructions for using the system.

Powering On TensiTrak Transmitter

The TensiTrak transmitter is powered by three D-cell alkaline batteries, which may be packaged together with heat shrink, or by one SuperCell lithium battery in an adapter. Three D-cell batteries or one SuperCell battery will power the transmitter for approximately 30 hours.

To power on the TensiTrak transmitter, remove the battery cap and insert either three individual or heat-shrunk D-cell alkaline batteries or one SuperCell battery in its adapter into the battery compartment positive terminals first, as shown below; then replace the battery cap.

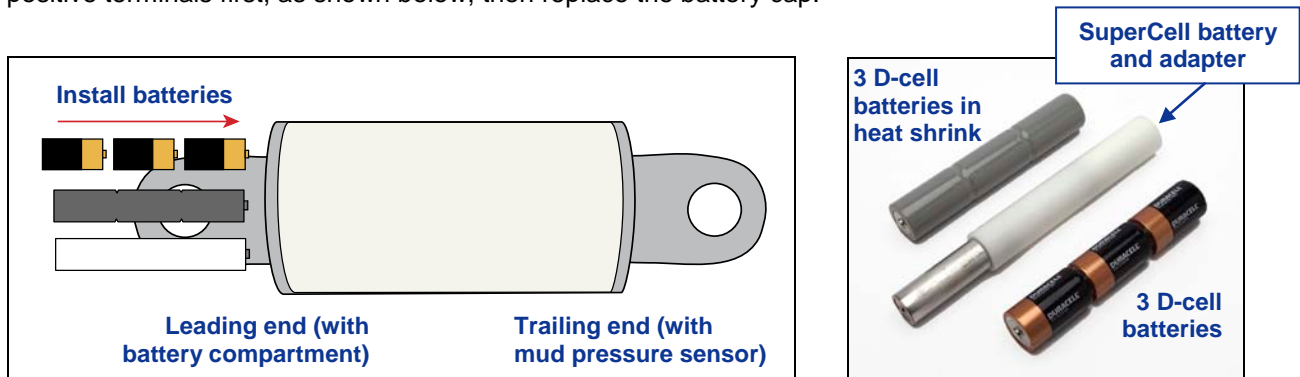

Loading Batteries into TensiTrak Transmitter

Once the batteries are properly installed and the battery cap is secure, the TensiTrak transmitter will zero any measurement data in memory and begin to measure and save data.

Setting up Receiver and Remote

Power up the F5 receiver, and then at the main menu click on the transmitter selection menu. From the transmitter selection menu, choose the TensiTrak option (right) to program your receiver so that it recognizes your TensiTrak transmitter.

The receiver will return to the main menu with the locate mode highlighted for selection. Click the trigger to go to the locate mode screen, which will appear as shown below.



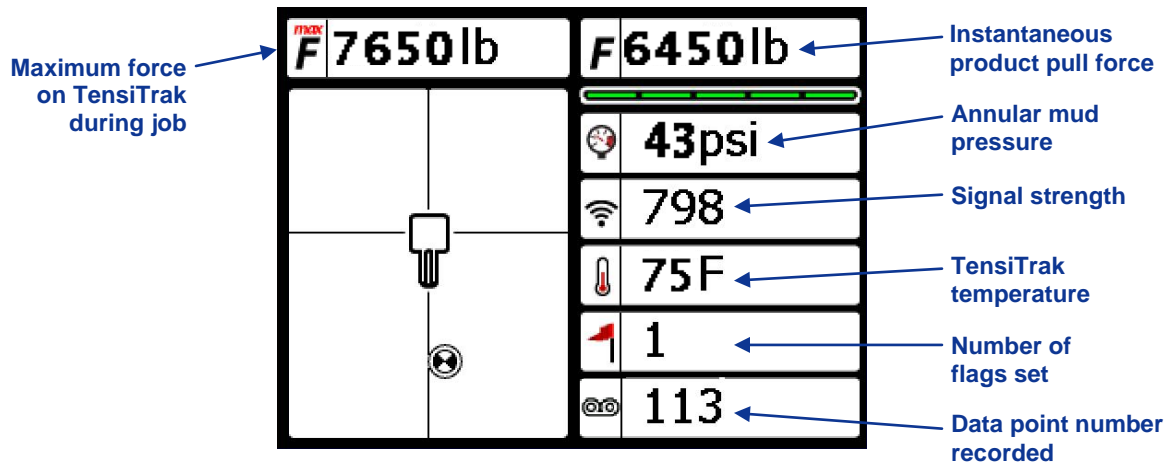

Receiver TensiTrak Locate Mode Screen

When the pressure-tension (P-T) DataLog function is enabled, the TensiTrak start recording menu will appear before the locate mode screen appears. The start recording menu allows you to choose to start a new TensiTrak job, append an existing job, or exit to the TensiTrak locate mode screen. See the next section, *Recording Data and Using Receiver Menus*, for instructions on how to use the P-T DataLog menus.

If the P-T DataLog function is disabled, the TensiTrak locate mode screen will appear automatically and no data recording will occur on the receiver.

NOTE: If a TensiTrak transmitter is not powered up or in range, then the TensiTrak locating mode screen on the receiver and on the remote will be blank.

After powering up the receiver, then power up the FSD or MFD remote. The TensiTrak screen will appear on the remote as shown below when displaying TensiTrak data.

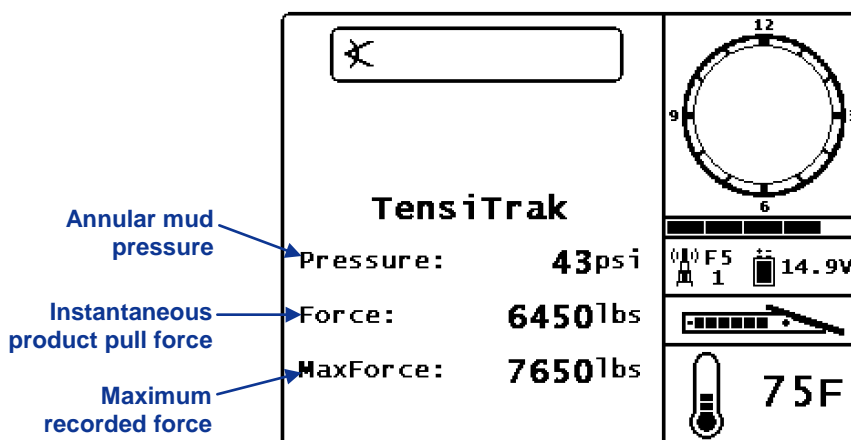

Remote Display TensiTrak Screen

Calibrating TensiTrak Transmitter to Receiver and Verifying Calibration

It is only necessary to calibrate the F5 receiver to the TensiTrak transmitter if you will be tracking its depth during installation. If you are only tracking the position (not depth) of the TensiTrak transmitter, then it is not necessary to calibrate. Calibration should be completed in an interference-free environment. The calibration area should be free of passive and active interference sources.

To calibrate your TensiTrak transmitter to your F5 receiver:

1. Using a tape measure, position the TensiTrak transmitter at a distance of 10 ft (3 m) from the receiver, as shown in the figure below; measure from the centerline of the transmitter to the inside edge of the receiver as shown below. Be sure to position the TensiTrak transmitter with the pulling eyes "open to the sky" (facing up and down) rather than with the pulling eyes on edge.

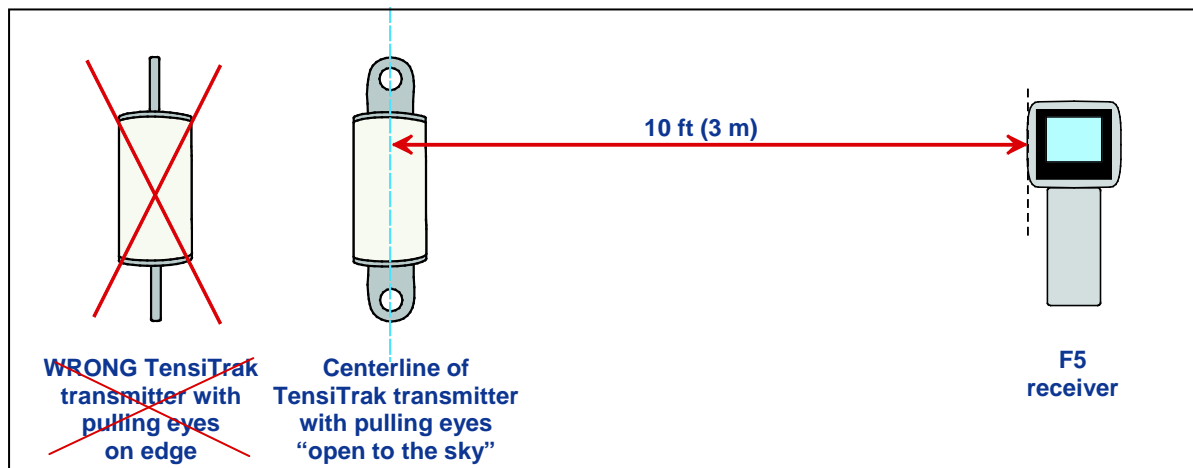

Calibration Setup

2. Confirm that TensiTrak data is being displayed on the TensiTrak locate mode screen on the receiver.
3. Open the receiver main menu, and select the calibration menu option.
4. From the calibration menu, select the 1-point calibration option.
5. Click the trigger to begin the calibration. Do not move the receiver or TensiTrak transmitter during calibration. A checkmark and four short beeps will confirm a successful calibration. If the calibration fails, verify the setup and try again or call DCI Customer Service.
6. After a successful calibration, the display will automatically return to the TensiTrak locate mode screen. If the P-T DataLog function is enabled, the start recording screen will appear. Select exit to view the data without recording it. If the P-T DataLog function is disabled, the TensiTrak locate mode screen will appear automatically.
7. Check the depth at two different locations to ensure a good calibration.

Setting Up TensiTrak Downhole Assembly

The TensiTrak downhole assembly consists of the following items in the order listed here: reamer, swivel, D-ring, TensiTrak transmitter, another D-ring, and the product, including the clevises required to connect the D-rings to the swivel and the product. If the diameter of the product is larger than the diameter of the TensiTrak transmitter, DCI recommends the use of a nonmetallic shroud to keep material from bridging between the reamer and the product. Be sure to inspect the mud pressure sensor to ensure it is clear of dirt and shows no wear or damage before assembling the TensiTrak transmitter with the other downhole parts.

The TensiTrak transmitter is installed into the downhole assembly and connected with D-rings so that it is positioned behind the reamer, between the swivel and the product as shown below

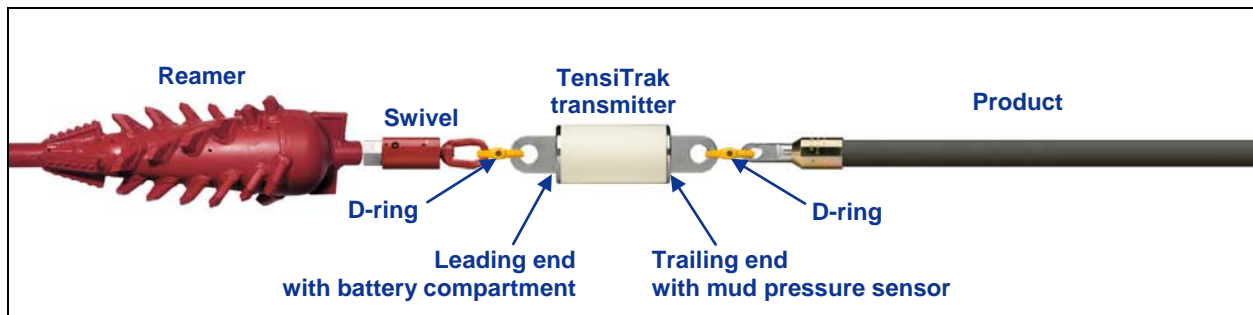

TensiTrak Downhole Assembly

It is critical that the TensiTrak transmitter's mud pressure sensor end is positioned as the trailing end to ensure that formation cuttings do not get packed around the sensor.

NOTE: If the TensiTrak transmitter's batteries are installed when the TensiTrak transmitter is under load, you will not get correct readings during the installation. You must remove and replace the three D-cell alkaline batteries when the TensiTrak transmitter is not under load. Because the TensiTrak transmitter begins measuring and saving data as soon as the batteries are installed, you may prefer to power on the transmitter after it is positioned with the rest of the downhole assembly near the pull-in area.

At this point, active monitoring is available on the receiver and the remote. If the P-T DataLog function is enabled and a job selection has been made, the TensiTrak data will be recorded under the job number indicated when the job selection was made. Recording is indicated by the data point number on the TensiTrak locate mode screen increasing every 4 seconds. Otherwise, no data will be recorded and the data point number on the TensiTrak locate mode screen will remain at zero.

Recording Data and Using Receiver Menus

Once your TensiTrak job is properly set up in the field, then you can begin to record data. As discussed previously, when the TensiTrak batteries are installed, the unit immediately begins saving data. The F5 receiver begins receiving, displaying, and saving data after the pressure-tension (P-T) DataLog function is enabled and a job has been started.

The receiver menus used to start, stop, and pause data recording, to record flags along the pullback/drill path, and to delete jobs from the receiver are discussed in this section. These menus are located under the P-T DataLog menu. The P-T DataLog menu is also used for the F5 fluid pressure transmitter, but only its applications for the TensiTrak system are addressed here.

Pressure-Tension DataLog Menu



Before you can record data, the P-T DataLog function must be enabled. From the receiver main menu, select the P-T DataLog option (icon shown above) to display the following menu.

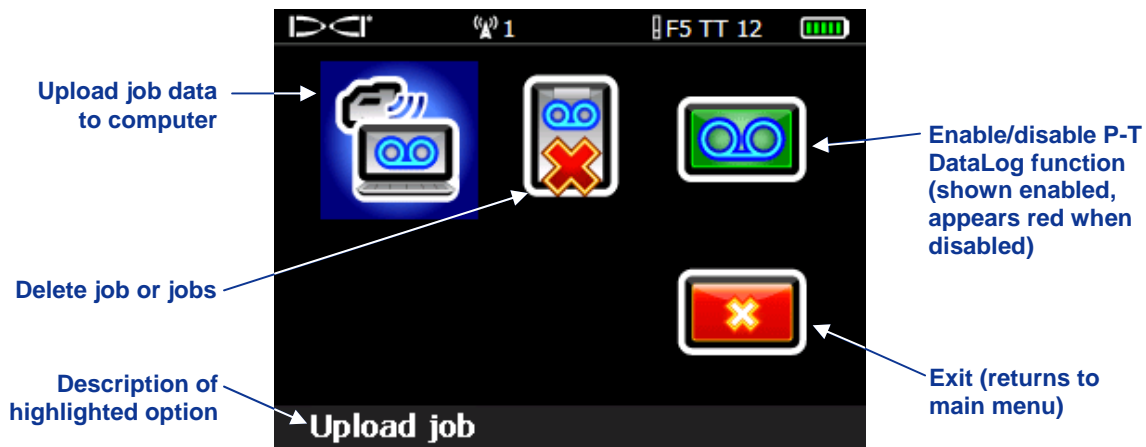

Pressure-Tension DataLog Menu

From this menu, select the option to enable/disable the P-T DataLog function if it is red (indicating the function is disabled). It will turn green (as shown above) to indicate the function is now enabled. If the option is green when you enter the menu, then the function is already enabled.

Start Recording Menu

With the P-T DataLog function enabled, the screen shown below will display when you click the trigger to go to the locate mode screen from the main menu. You can also access the recording menu from the locate mode by toggling right.

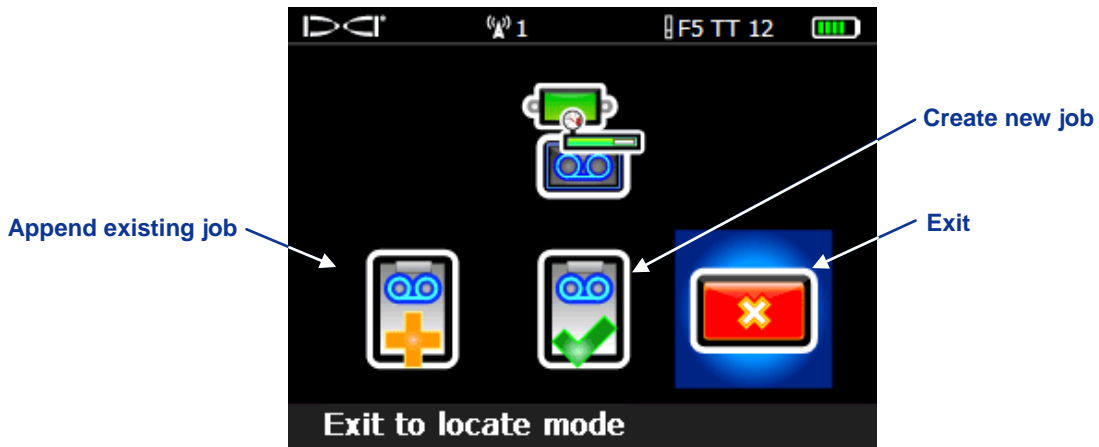

Start Recording Menu

To open a new job, select the start new job option. When starting a new job, note the job number for reference later. If you want to open an existing job and continue adding data to it, select the option to append existing job.

If you do not open a job (select exit), the start recording menu will display again when the toggle switch is pushed to the right. You must select either the option to start a new job or the option to append an existing job before a job will be opened and data recorded.

Once a selection is made, the locate mode screen will display showing TensiTrak data. If a recording option was chosen, the data point number recorded will advance every 4 seconds to show data is being recorded.

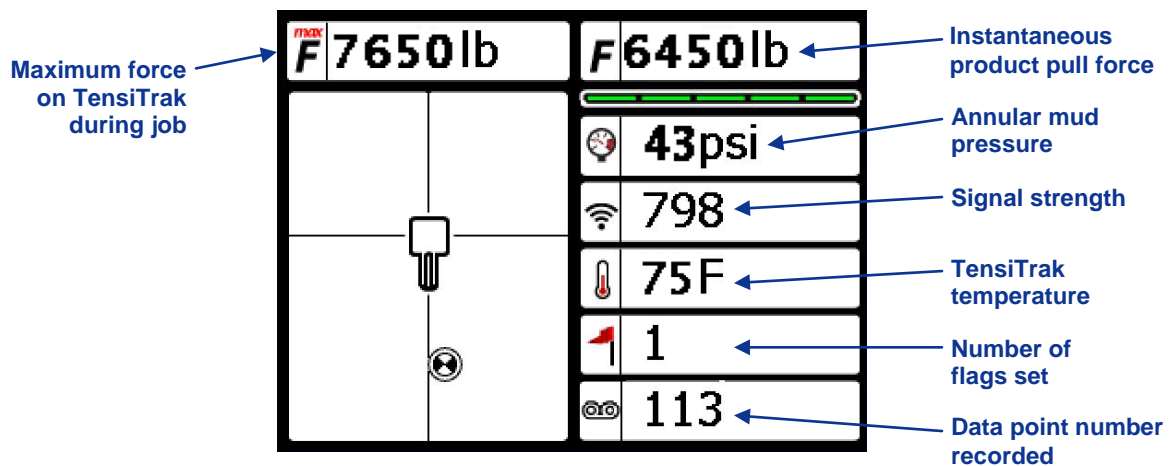

Receiver TensiTrak Locate Mode Screen

Stop/Pause Recording Menu

If a job is being recorded and you exit the locate mode screen (toggle down), the screen shown below will display.

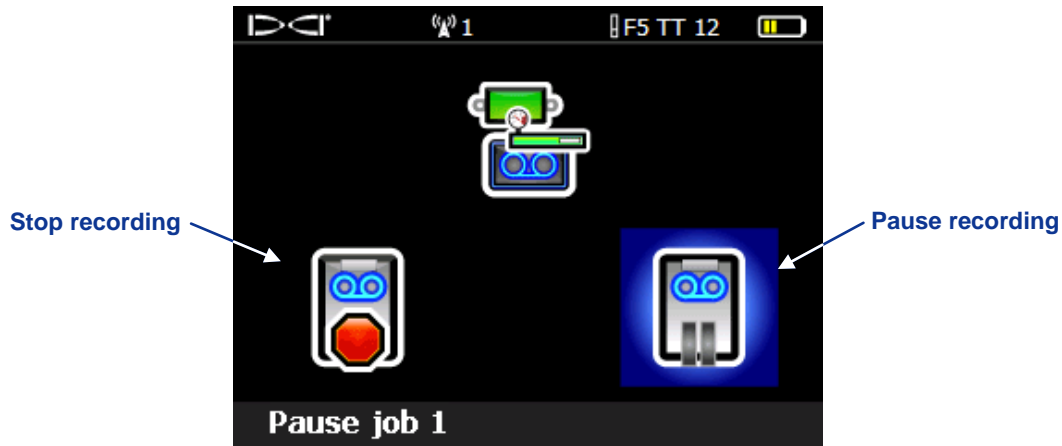

Stop/Pause Recording Menu

If you select the pause recording option, the job will remain open with no data recording until the receiver is shut down. When you re-enter the locate mode screen, the start recording menu will not display and data will automatically continue recording on the job number indicated.

The stop recording option will close the job. Once a job is closed, it is available for upload to a computer or it can be reopened and additional data can be recorded by selecting the option to append existing job in the start recording menu.

Flag Recording Menu

The flag recording menu is accessible only when a TensiTrak job is already running and the receiver is in locate mode. From the locate mode screen, push the toggle switch to the right, and the screen shown below will display.

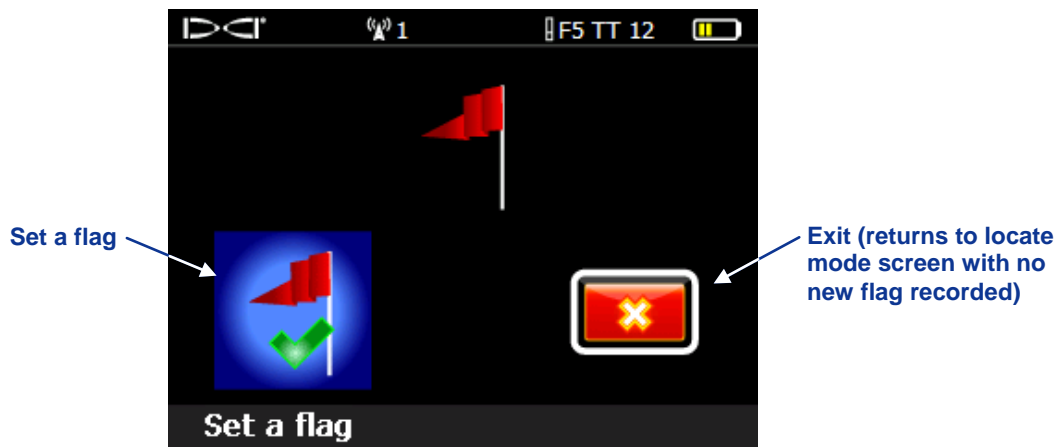

Flag Recording Menu

DCI recommends that you record flags at various points to help correlate physical locations along the pullback/drill path with the TensiTrak data points. To record a flag, from the flag recording menu, select the option to set a flag. Once a flag is recorded, it cannot be deleted from the TensiTrak data file. Keep a separate log of the flag numbers and details of the location where the flag was recorded (such as entering under road, exiting under road, etc.). You will want to add this information to the TensiTrak data file after it is uploaded to a computer.

If you do not want to set a flag, toggle right and select exit to return to the locate mode screen without recording a flag location.

Deleting TensiTrak Jobs

From the receiver main menu, select the P-T DataLog menu option. Then select the option to delete a job or jobs, and you will go to the delete TensiTrak jobs menu, shown below.

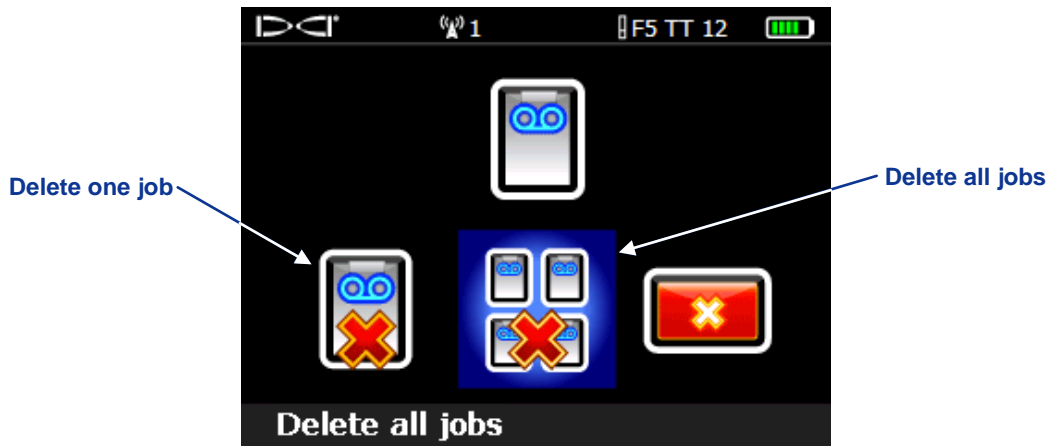

Delete TensiTrak Jobs Menu

You can either delete one job or delete all jobs in the receiver. Once you delete a job from the receiver, you cannot recover it. Make sure you have uploaded all jobs to the computer before you delete jobs from the receiver.

Installing LWD Software

Computer System Requirements

The LWD software requires a computer with at least the following system specifications:

- Microsoft Windows XP, Vista, or 7 operating system
- USB port
- Pointing device (mouse)
- Color printer for color graphs

The LWD software is provided on a USB flash drive that also contains this operator's manual, sample drill data, Bluetooth drivers, and software for using the system with an MFD remote. If you are using an MFD remote with your F5 system, please contact DCI Customer Service so that we can assist you in upgrading your MFD software.

Installation Instructions

The LWD program files will automatically be placed under the C:\Program Files folder in a new folder (C:\Program Files\DCI\DigiTrak LWD). You can change this default storage location during installation.

The LWD data files and sample data files will automatically be placed under My Documents\DCI. You can also change this default storage location during installation.

To install the LWD software:

1. Close any open applications.
2. Put the LWD flash drive into a USB port and view the contents of the drive in your computer. Click on the LWD Kit folder.
3. Double click on Drivers for LWD to install these first.
4. Double click on the Bluetooth Driver folder, then double click on the *.exe file to install the drivers.
5. Double click on the DigiTrak LWD Software folder, and then double click on the setup.exe file to install the LWD software.
6. Once the LWD drivers and software have been installed, you will see a shortcut icon  on your desktop and under All Programs in your Start menu (in lower left corner of computer screen).

You can start the program by using the LWD shortcut icon or the Start button path or by clicking on the DigiTrakLWD.exe file in Windows Explorer. When the program opens, a blank LWD application window will display, as shown below.

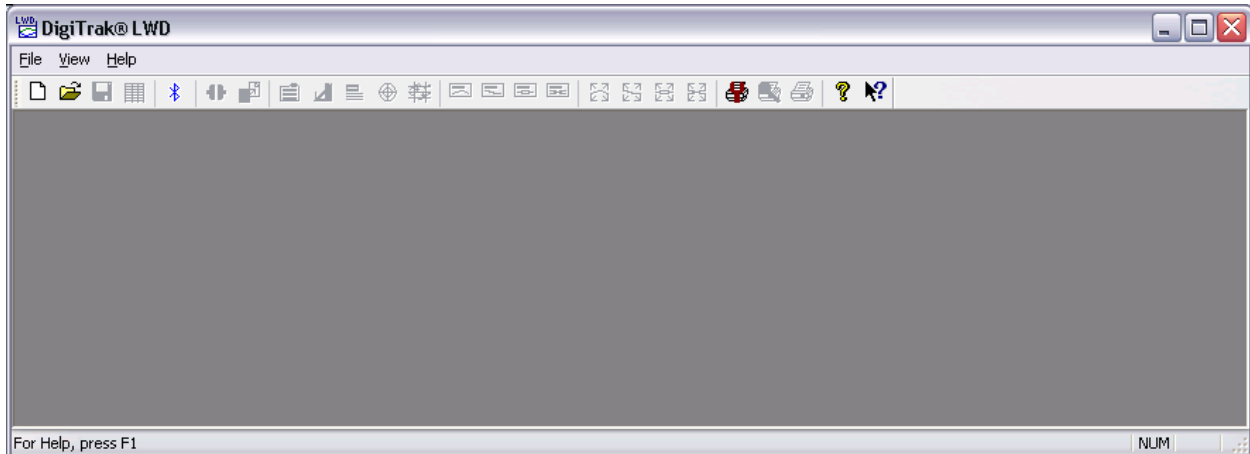

LWD Blank Application Window

For instructions on using the LWD software for the TensiTrak system, see the *Using LWD Software* section.

Uploading Data from Receiver to Computer

The instructions for uploading TensiTrak jobs from the F5 receiver to your computer are provided below. The procedure involves adding the F5 receiver to the LWD software's Bluetooth device list and then uploading the files to the computer via the Bluetooth connection. Only basic instructions for using the LWD software to upload data are discussed here. For full instructions on using the LWD software, see the next section, *Using LWD Software*.

Adding F5 Receiver to LWD Bluetooth Device List

The first time an F5 receiver is used with the LWD software on your computer, you must add it to the Bluetooth device list in the LWD software, as instructed here.

First, power up both the F5 receiver and the computer. Then, insert the Bluetooth USB adapter (Amp'd RF Model BT-210) into a USB port on the computer. Continue with the procedure as follows.

On the Receiver

1. Open the system information screen from the receiver main menu by selecting the system information option (icon shown to the right).
2. Note the receiver identification number and the Bluetooth device address, which you will need to enter into the LWD software on the computer.

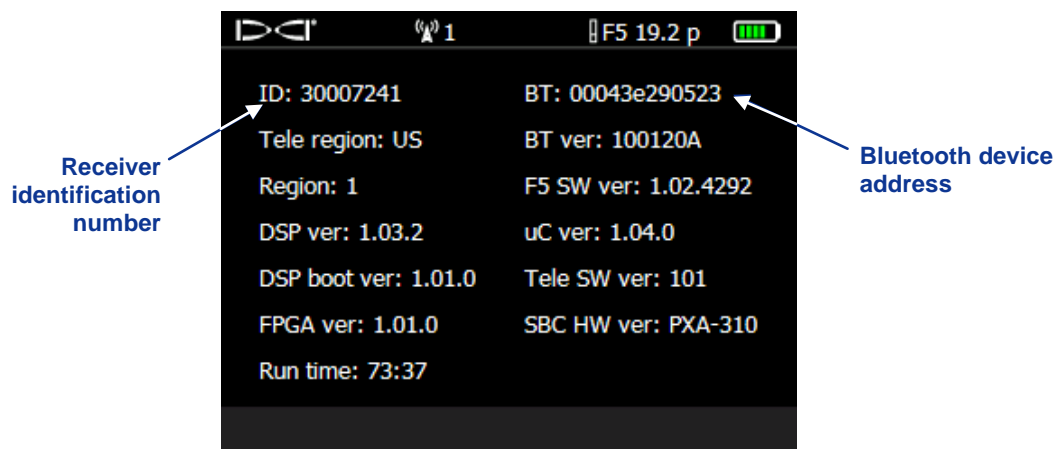

Receiver System Information Screen

On the Computer

1. Start up the LWD program by using the LWD shortcut icon or the Start button path or by clicking on the DigiTrakLWD.exe in Windows Explorer.
2. Select the **View | Bluetooth Device List** option on the menu bar or click on the Bluetooth icon  in the tool bar to open the Bluetooth Device List dialog box.

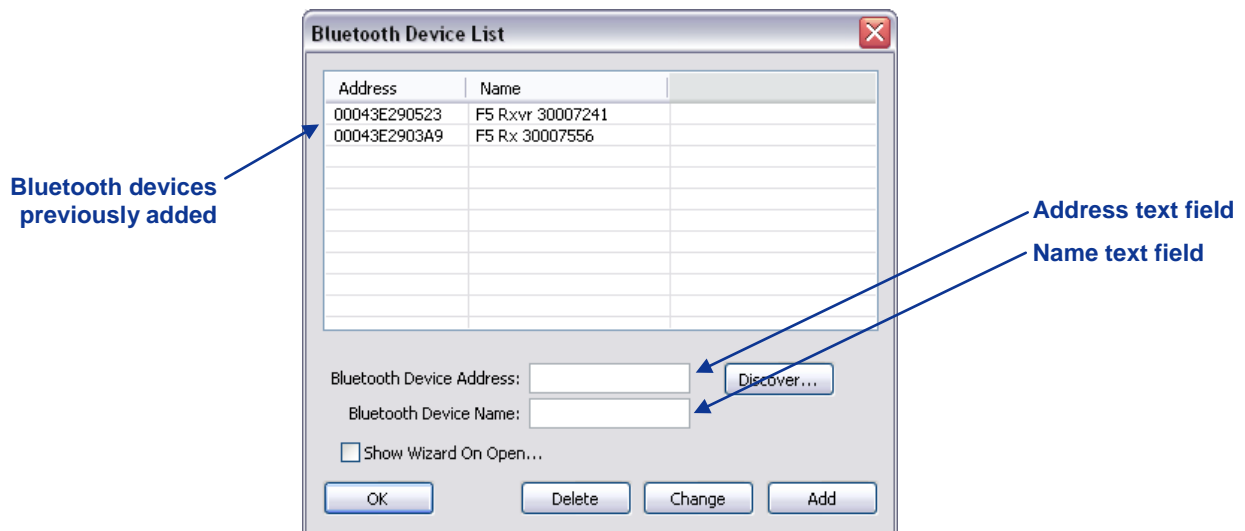

Bluetooth Device List Dialog Box

3. Enter the Bluetooth device address from the receiver system information screen in the specified text field.
4. Enter a name for the F5 receiver in the Bluetooth device name text field. We recommend that you use the receiver identification number shown on the receiver system information screen in the name.
5. Click on Add.
6. Click on OK. The device you added will appear in the Bluetooth device list.

You are now ready to upload job data.

Uploading Data from Receiver to Computer

Once the F5 receiver has been added to the Bluetooth device list, you can upload TensiTrak job files. DCI suggests that you upload your data to a computer following every TensiTrak job. The Bluetooth adapter must remain in the USB port of the computer during the upload process.

On the Receiver

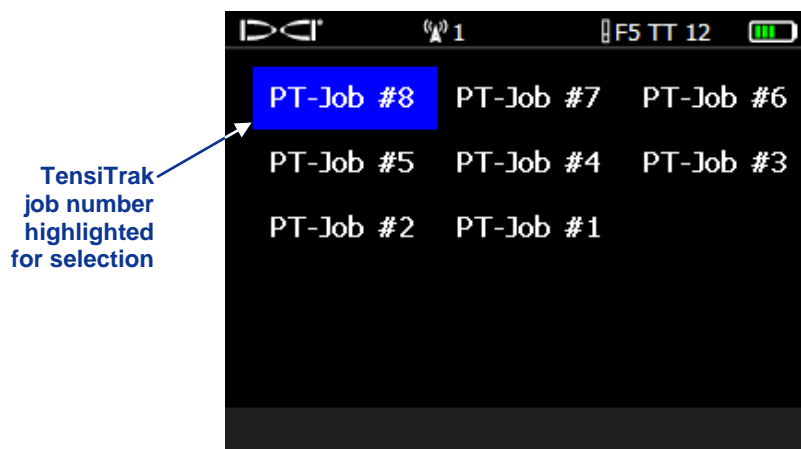

1. Open the pressure-tension DataLog menu from the receiver main menu.
2. Select the option to upload a job, and the P-T DataLog job list will display as shown below.



Pressure-Tension DataLog Job List

3. From the P-T DataLog job list, select the TensiTrak job number (for example, PT-Job #8 above) that you want to upload to the computer. Data must be communicated within 15 minutes or the receiver will shut down.

On the Computer

1. Start up the LWD program.
2. Select the **File | New** command on the menu bar or click on the new document icon  in the tool bar.
3. Select **Pressure-Tension | OK**, and a blank form will display.
4. Select **File | Upload Control** command on the menu bar or click on the connection icon  in the tool bar. The Pressure/Tension Monitor Upload Control dialog box will display.



5. Select “Silicon Labs CP210x USB to UART Bridge (COM#)” from the Serial Port Connection pull-down list.
6. Select the F5 receiver name from the Bluetooth pull-down list.
7. Click on “Connect to Device” to establish communication and begin the data transfer.
8. After the data has been transferred, the TensiTrak DataLog Job Info screen will appear. You may choose to enter the requested details now or later.
9. Click on OK. The data information fields and the force and pressure charts in the LWD application window will fill with data.

See the *Using LWD Software* section below and the help files in the LWD software for more information on interpreting, editing, and sharing the data.

Using LWD Software

Starting LWD Program and Opening Files

There are three ways to start the LWD program:

- Double-click on the LWD icon  on the desktop.
- Use the Start button (in lower left corner of computer screen) and select **Start | All Programs | DigiTrak LWD |  DigiTrak LWD.**
- From Windows Explorer, click on the DigiTrakLWD.exe file under the default folder “C:\Program Files\DCI\DigiTrak LWD” or the folder you have designated for the storage location.

After you start up the program, the application window will display without data, as shown in the *Installing LWD Software* section. From the blank application window, use the **File | New** command on the menu bar (or the new document icon  in the tool bar) to start a new TensiTrak job file. A blank form as shown below will display.

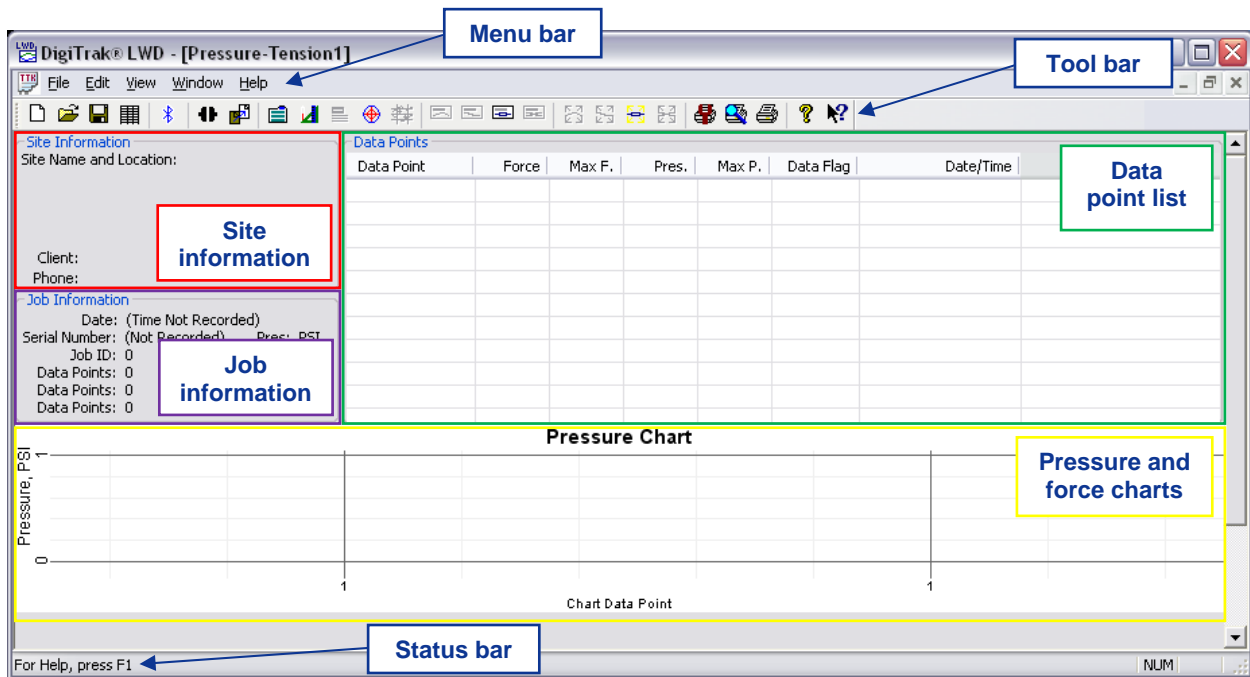

LWD Pressure-Tension Application Window (without data)

To open an existing TensiTrak file from the blank application window, use the **File | Open** command (or the file open icon). You can also open a TensiTrak file directly from Windows Explorer or as an email attachment. The file extension for a TensiTrak file is *.TT5. When a file is opened, the data information fields and the force and pressure charts are filled with data, as shown below.



LWD Pressure-Tension Application Window (with data)

The LWD application menus and tool bar icons are described in the following subsection, and the different information fields (site information, job information, data point list, and pressure and force charts) are described afterward.









Throughout the LWD program, a tool tip helper can be used to understand different parts of the application window and file. Click on the tool tip helper icon in the tool bar and click on a point of interest within the document.

Also, it is useful to view the help files in the LWD software and help wizards that appear to guide you through dialog box commands. If you do not want a help wizard to appear, click in the box next to "Show Wizard" to uncheck the box and close the help wizard.







Menu and Tool Bars

Under each menu item on the menu bar (**File**, **Edit**, **View**, **Window**, and **Help**) are commands for running the LWD program. Many of the commands are similar to those used in other Windows programs and have associated icons on the Tool bar. The menu commands and associated tool bar icons are summarized below. You can also move the cursor over any icon on the screen for a brief description of its function.

File Menu Commands

New		Opens the "New" project window where you select the job type to be created (pressure-tension for a TensiTrak job). Once a selection is made in this window, a new blank job screen appears.
Open		Allows you to select an existing project to open from the Windows browser.
Save		Saves an opened project using the same file name and folder as designated previously.
Save As		Saves an opened job to a specified file name and folder. When a new file has not been saved, selecting the save icon on the tool bar will open the same screen as the Save As menu command.
Print		Opens the print window where you can select printing options and print the job.
Print Preview		Displays the project on the screen as it would appear printed.
Print Setup		Allows you to select a printer and printer connection as well as the paper size and orientation.
Import Eclipse Data		Allows you to import Eclipse TensiTrak data files previously saved on a computer.
Export Spreadsheet		Exports a spreadsheet compatible comma-separated value (*.csv) Unicode text file so you can share charts using standard spreadsheet software.
Upload Data		Launches the Pressure/Tension Monitor Upload Control dialog box where you can link to a receiver for uploading files.
File 1, 2...		Opens the specified previously opened file.
Exit		Exits DigiTrak LWD program.

Edit Menu Commands

Site Information		Opens the Site Information dialog box where you can enter and edit the location and contact information that displays in the “Site Information” field in the upper left corner of the application window. General comments about the job may also be entered in the Site Information dialog box. This dialog box can also be accessed by double-clicking in the Site Information field of the application window.
Display Units		Opens the Edit Display Units dialog box where you can select the depth, pitch, temperature, and force/pressure units displayed on the charts in the application window. The depth unit setting in the receiver will determine the units that will display.
Job Information		Opens the TensiTrak DataLog Job Information dialog box where you edit details specifically associated with the TensiTrak job such as the upper limit for force and pressure readings acceptable for the job, the size and type of product being installed as well as the direction it was installed. This dialog box can also be accessed by double-clicking in the Job Information field of the application window.
Pressure Chart Annotations		Opens the Edit Pressure Chart Annotations dialog box where you can make comments and insert drawings to appear on the pressure chart. The pressure chart annotations dialog box can also be opened by holding the shift key down and using the mouse button to draw a box in the chart field.
Force Chart Annotations		Opens the Force Chart Annotations dialog box where you can make comments and insert drawings to appear on the force chart. The force chart annotations dialog box can also be opened by holding the shift key down and using the mouse button to draw a box in the chart field.
Pressure Chart Properties		Opens the Edit Pressure Chart Extents and Mode dialog box where you can adjust the scaling of the Pressure Chart.
Force Chart Properties		Opens the Edit Force Chart Extents and Mode dialog box where you can adjust the scaling of the Force Chart.

In addition to the commands listed above on the Edit menu, there are five options that are unavailable (grayed out) because they pertain to other LWD applications, such as the Short Steering Tool and the Drill DataLog applications.



View Menu Commands

Tool Bar		Shows or hides the tool bar.
Status Bar		Shows or hides the status bar.
Bluetooth Device List		Shows a list of registered Bluetooth devices.

Window Menu Commands

New Window		Opens the current document in a new window.
Cascade		Arranges windows in an overlapped fashion.
Tile		Arranges windows in nonoverlapped tiles.
Arrange Icons		Arranges icons of minimized windows.
Window 1, 2...		Goes to specified window.

Help Menu Commands

Help Topics		Offers you an index to topics on which you can get help.
Help About		Displays the version number of DigiTrak LWD software.
Tool Tip Helper		Serves as a shortcut to help topics. Click on this icon in the tool bar, and then click on a point of interest within the application. The help file associated with that part of the application window will open.

Information Fields

The P-T application in the LWD software displays information grouped in related fields as discussed briefly below. Detailed information on reading and editing the data fields are provided in the software's help files. Use the tool tip helper or view help topics for more information.

Site Information

The Site Information section displays the job location and client information. Visible on the screen are:

- Job Name
- Job Address line 1, line 2 and City.
- Client Name
- Contact Phone

All the address and contact information for the job, client, and contractor are listed on the printed document. See Print and Print Preview commands.

There are three ways to open the Site Information dialog box where Site Information can be edited. Select the Site Information command in the Edit menu. Click on the Site Information icon on the tool bar. Or double-click anywhere in the Site Information field of the application window.

Job Information

The Job Information section displays statistical information about the job. This information includes:

- **Date** the job was started on the F5 receiver, which is retrieved from first uploaded data point.
- **Serial number** of the receiver used to collect data
- **Job ID** or the number the job was on the receiver
- **Number of Data Points** collected
- **Pressure measurement units** (PSI or kPa - see Set Display Units)
- **Force measurement units** (lbf or kNt - see Set Display Units)

The data points, job ID, date, and measurement units are listed on the printed document. See Print and Print Preview commands.

The measurement units can be edited from the Display Units command in the Edit menu or by clicking the edit units icon from the tool bar.

There are three ways to open the Job Information dialog box where you can edit pressure and tension limit thresholds, the direction of the graphed data, as well as details about the materials which show on the printed document. Select the Job Information command in the Edit menu. Click on the Job Information icon on the tool bar. Or double-click anywhere in the Job Information field of the application window.

Data Point List

The Data Point list is a table displaying all of the data points in the job and the associated data. View help files for additional information. The columns in the table include:

- **Data Point**
This column displays the number and status of the data point.
- **Force**
This column displays the force value recorded by the receiver at the specified data point. Units are those displayed in the Job Information field. An "x" indicates no data.
- **Max F.**
This column displays the maximum force value recorded by the receiver at all data points up to the one indicated. Units are those displayed in the Job Information field. An "x" indicates no data.
- **Pres.**
This column displays the pressure value recorded by the receiver at the specified data point. Units are those displayed in the Job Information field. An "x" indicates no data.
- **Data Flag**
If a flag was recorded on the F5 receiver at a specified data point, the flag number would be noted in this column.
- **Date/Time**
This column displays the date and time the specified data point was recorded. This information does not show on the charts or printed report.

Pressure and Force Charts

The pressure and force charts give a graphical representation of the information contained in the Data Points field and can be annotated to provide additional details about the job. The common features of the two charts are discussed below. See the Help topics in the LWD software for more information.

- **Data Points** – The X-axis shows the numeric value of the charted data points.
- **Values** – The Y-axis of each graph shows the corresponding pressure or force value of the points on the graph.
- **Cursor Coordinates** – When the cursor is placed anywhere on either graph, the value of the coordinates at that position display. If the cursor is placed on a data point, both the force and pressure values recorded at that data point will display.
- **Flags** – When a flag is set at a data point, a green dot larger than the data point appears with the flag number indicated nearby.
- **Zoom** – To zoom into an area of the chart, hold down the control button on your computer then click and hold on your mouse while you drag the pointer through the area you wish to explode. Release the mouse button once the area is selected. To return the chart to its normal scaling, hold the control button down on the computer and click the mouse button in the chart area.

Mud Pressure Chart

The Mud Pressure Chart shows the downhole mud pressure (in pounds-per-square-inch or kilo-Pascals) at each data point. If a pressure limit threshold was set, data points will be magenta or red as the pressure threshold is approached or exceeded. In the case below, the pressure limit threshold was set to 45 psi.

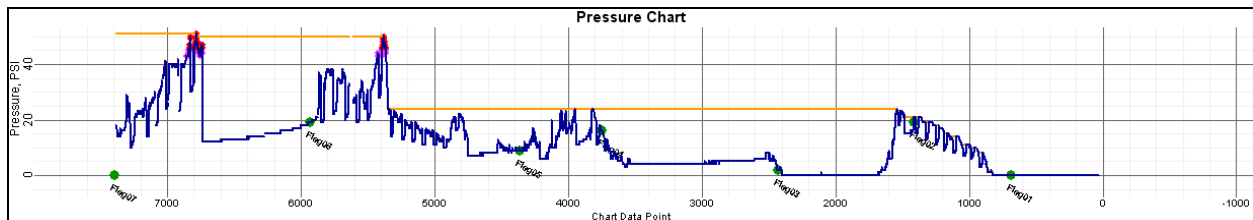

Mud Pressure Chart

Pull Force Chart

The Pull Force Chart shows the product pull force measured in force-pounds (lbf) or kilo-Newtons (kN) at each data point. If a force limit threshold was set, data points will be magenta or red as the force threshold is approached or exceeded. In the case below, the force limit threshold was set to 40,000 lbf.

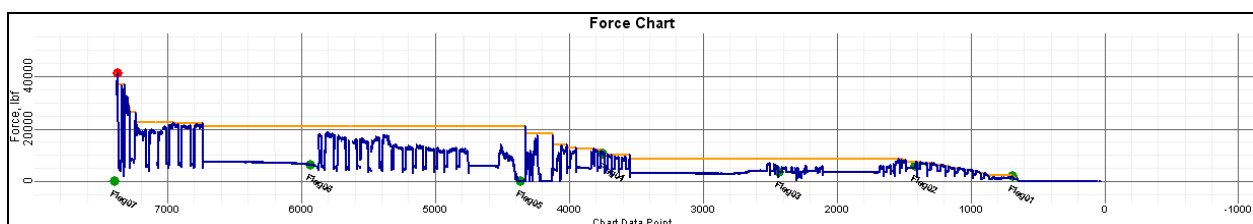

Pull Force Chart

Editing and Annotating Charts

The Pressure and Force charts can be edited and annotated in a number of ways. Data points can be removed in the Data Points list to reduce the amount of data that appears on the charts. Shapes and captions can be drawn directly on the chart to describe job site conditions and other points of interest on the graph using the Edit Chart Annotations commands. And the boundaries of the charts can be changed using the Edit Chart Properties commands. The help files in the LWD software provide full instruction on all editing capabilities. The instructions below are basic to getting started with the chart editing functions.

Removing Data Points

Select a group of data points to remove from the graphs by clicking on either chart near where you would like to begin removing data. The Data Points list will adjust to show the group of data points near where the click was made. Click on the first data point you would like to remove from the list and hold the shift key down. Then click on the last data point you would like to remove from the list. Right click in the Data Points list area and select the Remove option. The data points you selected will no longer show on the charts. The Data Points list will indicate the points have been removed from the chart.

Drawing Shapes and Adding Captions

There are three ways you can access the Pressure or Force Chart Annotations dialog boxes where you can draw shapes and enter information to be included on the chart graph and printed report.

- Select the Pressure or Force Chart Annotations command from the Edit menu.
- Click on the Edit Force or Pressure Chart Annotations icon on tool bar.
- Or hold the shift key down and use the mouse to draw a box around the area you would like a shape to appear on the chart. If the box is drawn in the pressure chart, the pressure annotations dialog box will open. If the box is drawn in the force chart, the force annotations dialog box will open. The Location area of the dialog box will be automatically filled with the coordinates of the box you drew.

Both the pressure and force annotation boxes function in the same way, only the coordinates shown in the Location and Caption sections of the dialog boxes will be different. If you open the chart annotations dialog box using the menu command or tool bar icon, you will need to enter the coordinates of the shape you wish to draw in the Location section of the dialog box.

Selecting and Editing Shapes

Select the shape you would like to appear on the chart from the pull-down menu in the Location section of the chart annotations dialog box.

Adjust the line weight and font size in the Line/Font section of the dialog box.

Select which parts of the shape you would like to appear in the Draw Shape section of the dialog box.

The color of the different parts of the shape can be adjusted by double clicking on the ellipses in the Draw Shape section of the dialog box.

Adding Captions

Before a caption can be entered, the check box next to “Draw Caption” in the Draw Shape section of the chart annotations dialog box must be checked to activate the Caption section of the dialog box. With the Caption section of the dialog box active, type the words you would like to appear on the graph in the Caption text box. You do not have to draw a shape to add a caption.

If a shape is drawn, the caption will appear centered in the shape by default.

To change the location or orientation of where the caption appears, click in the box next to “Top-Left” in the caption section of the dialog box. Enter the coordinates of where you would like the text to begin.

To change the orientation of the text, type the value of the slope of the text in the Text Slope text box.

Editing Chart Properties

To open the Pressure or Force Chart properties dialog boxes where properties such as chart boundaries and scaling can be adjusted.

- Select the Pressure or Force Chart Properties command from the Edit menu.
- Click on the Edit Force or Pressure Chart Properties icon on tool bar.

Auto Scale is selected by default. Click in the box next to Auto Scale to adjust the horizontal or vertical scaling and chart boundaries. Then manually enter the coordinates of chart boundaries as you would like them to appear.

Printing and Previewing Project Reports

1. To preview the printed pages before you send the file to print, select **Print Preview** from the **File** menu or click on the print preview icon on the tool bar. To close the print preview and return to the document, click on “Close” in the print preview window. To print the document from the print preview window, click on the “Print” button.
2. To edit printing properties such as the printer, paper size and orientation, select **Print Setup** from the **File** menu or click on the print setup icon on the tool bar.
3. There are three ways to print the job data.
 - Select **Print** from the **File** menu.
 - Click on the print icon on the tool bar.
 - Or click on “Print” in the Print Preview window.
4. After a printing option is selected, a Print dialog box will appear. Make any adjustments needed in the Print dialog box, then click OK. If you have the Adobe Acrobat PDF writer software, you can select the Adobe PDF printer to print to a PDF file (see your Adobe software documentation).
5. The job data will print on at least three pages.

On the first page, the job information including location, client, and contractor information, if entered, will appear along with the statistical data about the job and job comments, if any. On the second page the force and pressure charts will appear. And on the third page (and more if needed), the top 15% of pullback data will be listed by default. You may also select data points to be printed in the data point list by right-clicking on a data point and selecting the print option. See the help files for more information.

Saving Project Files

1. To save an open project file, select **Save** from the **File** menu or click on the Save icon on the tool bar. If the file has been previously named and saved, it will automatically be saved under its current file name (shown on the left in the title bar at the top of the main application window) and location. If the project is new and has not yet been saved and named, then the Save As window will open where you can edit the file name and select the location. The default file name is Pressure-Tension#.tt5. The # position starts at 1 and advances automatically as files are saved.
2. To save an open file with a different file name or location, select **Save As** from the **File** menu. You will see the Save As dialog box, which automatically opens to the folder where the current file is saved. Change the file name and location as desired, then click **Save**. The open file will now have the new file name and/or location.

DCI recommends saving each job file with two different names in the event that one file becomes corrupted.

E-mailing Report to Customer Who Does Not Have LWD Software

The LWD software is able to generate a printed report of your document.

If you want to send an electronic copy of this printed report, we suggest using a document generating printer driver to create a common readable file such as PDF using any of the following:

- **PrimoPDF**
This free software is available for download online at www.primopdf.com. With this software installed, you can print the report to PrimoPDF instead of your printer and save the report as a PDF file. This file can then be attached to an e-mail. Please refer to PrimoPDF for instructions in the use of this product.
- **Bullzip PDF Printer**
This free software is available for download online at www.bullzip.com. With this software installed, you can print the report to Bullzip PDF Printer and save the report as a PDF file. This file can then be attached to an e-mail. Please refer to Bullzip for instructions in the use of this product.
- **Microsoft XPS Printer**
Microsoft has generated a nonstandard encapsulated post script format called .XPS. It is a standard Windows component and will probably appear in your printer list. Only Microsoft Internet Explorer can present this document type without a translator. If I.E. is not your default browser then you or your customer may not be able to view this file type. Please refer to <http://windows.microsoft.com/en-US/windows-vista/Print-to-the-Microsoft-XPS-Documents-Writer> for instructions on use with your specific operating system.

Additional information can be found at the website: help.digitrak.com

Once you have a document writer installed:

1. From the File menu or the Tool bar, select Print
2. In the pull-down list, select your PDF writer or Microsoft XPS Document Writer
3. Click on the 'Properties' button to select 'Portrait' or 'Landscape' format (Landscape is recommended).
4. Click OK to save orientation and dismiss the 'Properties' dialog.
5. Click OK to save as a *.pdf or *.xps file type.
6. The 'Save As' dialog will appear.
7. Choose the location for your file.
8. Choose the name for your file.
9. Click OK to save or Cancel to exit.
10. Attach the saved file (sample.pdf or sample.xps) to your e-mail. The customer can view the file in a PDF compatible viewer such as Adobe or a Microsoft XPS compatible viewer such as Internet Explorer.

Alternatively, the printed document can be scanned and attached to an e-mail.



Notes

3-1500-00-A1

Appendix: System Specifications and Maintenance Requirements

The power requirements, environmental requirements, data accuracy specifications, and maintenance requirements for the DigiTrak TensiTrak Pullback and Pressure Monitoring System are listed below.

Power Requirements

Device (Model Number)	Operational Voltage	Operational Current
DigiTrak TensiTrak Tension Monitor (TT and TT5)	2.7–4.8 V ===	300 mA max

Environmental Requirements

Device	Relative Humidity	Operating Temperature
DigiTrak TensiTrak Tension Monitor	<100%	36° to 104°F (2° to 40°C)

Tension Monitor Pull-Force Data Accuracy

Temperature Range	Tension Range	Accuracy
36° to 41°F (2° to 5°C)	Full	± 5k lb (22.5 kN)
41° to 104°F (5° to 40°C)	0–10k lb (0–44 kN)	± 1k lb (4.5 kN)
41° to 104°F (5° to 40°C)	10k–20k lb (45 kN–89 kN)	± 2k lb (9 kN)
41° to 104°F (5° to 40°C)	20k–100k lb (90 kN–444 kN)	± 3k lb (13.5 kN)

Operating the TensiTrak tension monitor outside of the specified operating temperature range will result in tension readings outside of the specifications.

Mud Pressure Data Accuracy

Temperature Range	Pressure Range	Accuracy
36° to 104°F (2° to 40°C)	0–75 psi (0–517 kPa)	± 3 psi (21 kPa)
36° to 104°F (2° to 40°C)	75–127 psi (517–876 kPa)	± 10%

General Transmitter Care Instructions

- Periodically clean the spring and threads inside the battery compartment as well as the spring and threads of the battery end cap to ensure a proper power connection with the batteries. An emery cloth or wire brush can be used to remove any oxidation that has built up. Be careful not to damage the battery cap O-ring; remove it while cleaning if necessary. After cleaning, use a conductive lubricant on the battery cap threads to keep the battery cap from binding in the battery compartment.

NOTE: All DCI battery-powered transmitters are shipped with a nickel-based anti-seize lubricant on the battery end cap, which aids in electrical grounding for better battery performance.

- Before use, inspect the battery cap O-ring for damage that may allow water to enter the battery compartment. Replace the O-ring if the one installed becomes damaged.
- Send in the Product Registration Card for the 90-day Limited Warranty.

Battery Pack Storage

If you plan to store the battery packs for any period of time, please follow the guidelines listed below.

- Do not store the battery pack at temperatures greater than 113°F (45°C).
- Do not store the battery pack in a fully discharged state.
- Do not store the battery pack in the battery charger.
- If the battery pack is going to be stored for an extended period of time, precharge the battery to a charge level of 30% to 50% (two or three LEDs illuminated on the battery pack). The battery pack should not be stored for more than one year unless it is periodically recharged to the 30% to 50% level.

LIMITED WARRANTY

Digital Control Incorporated ("DCI") warrants that when shipped from DCI each DCI Product will conform to DCI's current published specifications in existence at the time of shipment and will be free, for the warranty period ("Warranty Period") described below, from defects in materials and workmanship. The limited warranty described herein ("Limited Warranty") is not transferable, shall extend only to the first end-user ("User") purchasing the DCI Product from either DCI or a dealer expressly authorized by DCI to sell DCI Products ("Authorized DCI Dealer"), and is subject to the following terms, conditions and limitations:

1. A Warranty Period of twelve (12) months shall apply to the following new DCI Products: receivers/locators, remote displays, battery chargers and rechargeable batteries, and DataLog® modules and interfaces. A Warranty Period of ninety (90) days shall apply to all other new DCI Products, including transmitters, accessories, and software programs and modules. Unless otherwise stated by DCI, a Warranty Period of ninety (90) days shall apply to: (a) a used DCI Product sold either by DCI or by an Authorized DCI Dealer who has been expressly authorized by DCI to sell such used DCI Product; and (b) services provided by DCI, including testing, servicing, and repairing an out-of-warranty DCI Product. The Warranty Period shall begin from the later of: (i) the date of shipment of the DCI Product from DCI, or (ii) the date of shipment (or other delivery) of the DCI Product from an Authorized DCI Dealer to User.

2. DCI's sole obligation under this Limited Warranty shall be limited to either repairing, replacing, or adjusting, at DCI's option, a covered DCI Product that has been determined by DCI, after reasonable inspection, to be defective during the foregoing Warranty Period. All warranty inspections, repairs and adjustments must be performed either by DCI or by a warranty claim service authorized in writing by DCI. All warranty claims must include proof of purchase, including proof of purchase date, identifying the DCI Product by serial number.

3. The Limited Warranty shall only be effective if: (i) within fourteen (14) days of receipt of the DCI Product, User mails a fully completed Product Registration Card to DCI; (ii) User makes a reasonable inspection upon first receipt of the DCI Product and immediately notifies DCI of any apparent defect; and (iii) User complies with all of the Warranty Claim Procedures described below.

WHAT IS NOT COVERED

This Limited Warranty excludes all damage, including damage to any DCI Product, due to: failure to follow DCI's operator's manual and other DCI instructions; abuse; misuse; neglect; accident; fire; flood; Acts of God; improper applications; connection to incorrect line voltages and improper power sources; use of incorrect fuses; overheating; contact with high voltages or injurious substances; use of batteries or other products or components not manufactured or supplied by DCI; or other events beyond the control of DCI. This Limited Warranty does not apply to any equipment not manufactured or supplied by DCI nor, if applicable, to any damage or loss resulting from use of any DCI Product outside the designated country of use. By accepting a DCI Product and not returning it for a refund within thirty (30) days of purchase, User agrees to the terms of this Limited Warranty, including without limitation the Limitation of Remedies and Liability described below, and agrees to carefully evaluate the suitability of the DCI Product for User's intended use and to thoroughly read and strictly follow all instructions supplied by DCI (including any updated DCI Product information which may be obtained at the above DCI website). In no event shall this Limited Warranty cover any damage arising during shipment of the DCI Product to or from DCI.

User agrees that the following will render the above Limited Warranty void: (i) alteration, removal or tampering with any serial number, identification, instructional, or sealing labels on the DCI Product, or (ii) any unauthorized disassembly, repair or modification of the DCI Product. In no event shall DCI be responsible for the cost of or any damage resulting from any changes, modifications, or repairs to the DCI Product not expressly authorized in writing by DCI, and DCI shall not be responsible for the loss of or damage to the DCI Product or any other equipment while in the possession of any service agency not authorized by DCI.

DCI reserves the right to make changes in design and improvements upon DCI Products from time to time, and User understands that DCI shall have no obligation to upgrade any previously manufactured DCI Product to include any such changes.

THE FOREGOING LIMITED WARRANTY IS DCI'S SOLE WARRANTY AND IS MADE IN PLACE OF ALL OTHER WARRANTIES, EXPRESS OR IMPLIED, INCLUDING BUT NOT LIMITED TO THE IMPLIED WARRANTIES OF MERCHANTABILITY AND FITNESS FOR A PARTICULAR PURPOSE AND ANY IMPLIED WARRANTY ARISING FROM COURSE OF PERFORMANCE, COURSE OF DEALING, OR USAGE OF TRADE, ALL OF WHICH ARE HEREBY DISCLAIMED AND EXCLUDED. If DCI has substantially complied with the warranty claim procedures described below, such procedures shall constitute User's sole and exclusive remedy for breach of the Limited Warranty.

LIMITATION OF REMEDIES AND LIABILITY

In no event shall DCI or anyone else involved in the creation, production, or delivery of the DCI Product be liable for any damages arising out of the use or inability to use the DCI Product, including but not limited to indirect, special, incidental, or consequential damages, or for any cover, loss of information, profit, revenue or use, based upon any claim by User for breach of warranty, breach of contract, negligence, strict liability, or any other legal theory, even if DCI has been advised of the possibility of such damages. In no event shall DCI's liability exceed the amount User has paid for the DCI Product. To the extent that any applicable law does not allow the exclusion or limitation of incidental, consequential or similar damages, the foregoing limitations regarding such damages shall not apply.

This Limited Warranty gives you specific legal rights, and you may also have other rights which vary from state to state. This Limited Warranty shall be governed by the laws of the State of Washington.

WARRANTY CLAIM PROCEDURES

1. If you are having problems with your DCI Product, you must first contact the Authorized DCI Dealer where it was purchased. If you are unable to resolve the problem through your Authorized DCI Dealer, contact DCI's Customer Service Department in Kent, Washington, USA at the above telephone number between 6:00 a.m. and 6:00 p.m. Pacific Time and ask to speak with a customer service representative. (The above "800" number is available for use only in the USA and Canada.) Prior to returning any DCI Product to DCI for service, you must obtain a Return Merchandise Authorization (RMA) number. Failure to obtain an RMA may result in delays or return to you of the DCI Product without repair.

2. After contacting a DCI customer service representative by telephone, the representative will attempt to assist you in troubleshooting while you are using the DCI Product during actual field operations. Please have all related equipment available together with a list of all DCI Product serial numbers. It is important that field troubleshooting be conducted because many problems do not result from a defective DCI Product, but instead are due to either operational errors or adverse conditions occurring in the User's drilling environment.

3. If a DCI Product problem is confirmed as a result of field troubleshooting discussions with a DCI customer service representative, the representative will issue an RMA number authorizing the return of the DCI Product and will provide shipping directions. You will be responsible for all shipping costs, including any insurance. If, after receiving the DCI Product and performing diagnostic testing, DCI determines the problem is covered by the Limited Warranty, required repairs and/or adjustments will be made, and a properly functioning DCI Product will be promptly shipped to you. If the problem is not covered by the Limited Warranty, you will be informed of the reason and be provided an estimate of repair costs. If you authorize DCI to service or repair the DCI Product, the work will be promptly performed and the DCI Product will be shipped to you. You will be billed for any costs for testing, repairs and adjustments not covered by the Limited Warranty and for shipping costs. In most cases, repairs are accomplished within 1 to 2 weeks.

4. DCI has a limited supply of loaner equipment available. If loaner equipment is required by you and is available, DCI will attempt to ship loaner equipment to you by overnight delivery for your use while your equipment is being serviced by DCI. DCI will make reasonable efforts to minimize your downtime on warranty claims, limited by circumstances not within DCI's control. If DCI provides you loaner equipment, your equipment must be received by DCI no later than the second business day after your receipt of loaner equipment. You must return the loaner equipment by overnight delivery for receipt by DCI no later than the second business day after your receipt of the repaired DCI Product. Any failure to meet these deadlines will result in a rental charge for use of the loaner equipment for each extra day the return of the loaner equipment to DCI is delayed.